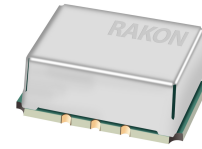

SMD Temperature Compensated Voltage Controlled Crystal Oscillator (PLUTO)

A highly versatile series of surface mountable 14.7 x 9.2 x 6.2 mm Temperature Compensated Voltage Controlled Crystal Oscillators (TCVCXOs) for applications where small size and high performance are prerequisites.

Product description

This CFPT9050 uses Rakon's proprietary ASIC 'Pluto™', a single chip oscillator and analogue compensation circuit, capable of sub 0.3ppm performance. Its wide frequency range, operating temperature range, drive capability, coupled with its high stability and linear frequency pulling, make it the ideal reference oscillator. Its ability to function down to a supply voltage of 2.4 volts and low power consumption makes it particularly suitable for mobile applications.

**Applications**

- Communications
- Other

Features

- Low power consumption
- Sub 0.3ppm stability over extended temperature range
- Wide frequency range

Specifications**1.0 SPECIFICATION REFERENCES**

Line	Parameter	Description
1.1	Model Description	CFPT9050
1.2	RoHS compliant	Yes, part numbers with suffix 'LF' (non-RoHS version available upon request)
1.3	Package size available	14.7mm x 9.2mm

2.0 FREQUENCY CHARACTERISTICS

Line	Parameter	Test Condition	Value	Unit
2.1	Frequency range	Frequency range available dependent on output type: refer to note 1	1 to 80	MHz
2.2	Frequency calibration	Initial calibration @ 25°C	±0.5 max	ppm
2.3	Reflow shift	Measured ≥ 60 minutes after reflow	±1 max	ppm
2.4	Frequency stability over temperature	Stability reference to (Fmax + Fmin)/2	±0.3 to 2.5	ppm
2.5	Temperature range	Operating temperature range over which temperature stability is measured.	-55 to 105	°C
2.6	Supply voltage stability	Supply voltage varied ±10% at 25°C (dependent on frequency and output type). Typical:	±0.2	ppm
2.7	Load sensitivity	15pF±5pF (dependent on frequency and output type). Typical:	±0.2	ppm
2.8	Long term stability	first year, ≤ 20MHz	±1 max	ppm
2.9	Long term stability	first year, > 20MHz	±2 max	ppm
2.10	Long tem stability	10 years, ≤ 20MHz	±3 max	ppm
2.11	Long term stability	10 years, > 20MHz	±5 max	ppm

3.0 POWER SUPPLY

Line	Parameter	Test Condition	Value	Unit
3.1	Supply voltage	Nominal supply voltage range	2.4 to 6	V
3.2	Current Sinewave	dependent on frequency	6 to 12	mA
3.3	Current HCMOS	typically: $1 + \text{frequency(MHz)} * \text{supply(V)} * \{\text{load(pF)} + 15\} * 10^{-3} \text{mA}$ e.g 20MHz, 5V, 15pF = 4mA		mA
3.4	Current ACMOS	typically: $1 + \text{frequency(MHz)} * \text{supply(V)} * \{\text{load(pF)} + 23\} * 10^{-3} \text{mA}$		mA
3.5	Current Clipped Sinewave	typically: $1 + \text{frequency(MHz)} * 1.2 * \{\text{load(pF)} + 30\} * 10^{-3} \text{mA}$		mA

4.0 CONTROL VOLTAGE

Line	Parameter	Test Condition	Value	Unit
4.1	Control voltage range	Without reference voltage; $V_s = 5.0V$	0.5 to 4.5	V
4.2	Control voltage range	Without reference voltage; $V_s = 3.3V$	0.65 to 2.65	V
4.3	Control voltage range	With reference voltage: 0 to V_{ref}		V
4.4	Frequency tuning	Standard ageing adjustment $\leq 20\text{MHz}$: $\pm 5\text{ppm}$, $> 20\text{MHz}$: $\pm 7\text{ppm}$. Increased pulling optional (see note 2)	± 5 to 20	ppm
4.5	Port input impedance	Measured between control voltage and GND pin	100 min	k Ω
4.6	Linearity		1 max	%
4.7	Slope	Positive		
4.8	Modulation bandwidth		2 min	kHz

5.0 OSCILLATOR OUTPUT-AC COUPLED CLIPPED SINEWAVE

Line	Parameter	Test Condition	Value	Unit
5.1	Output waveform	AC coupled clipped sinewave		
5.2	Output voltage level	Peak to peak voltage measured at minimum supply voltage	0.8 min	V
5.3	Output load resistance		10	k Ω
5.4	Output load capacitance		10	pF

6.0 OSCILLATOR OUTPUT-AC COUPLED SINEWAVE

Line	Parameter	Test Condition	Value	Unit
6.1	Output waveform	AC coupled sinewave		
6.2	Output voltage level	Peak to peak voltage measured at minimum supply voltage $\leq 20\text{MHz}$	1 min	V
6.3	Output voltage level	Peak to peak voltage measured at minimum supply voltage $> 20\text{MHz}$	0.5 min	V
6.4	Output load resistance	Operating range	10	k Ω
6.5	Output load capacitance	Operating range	10	pF

7.0 OSCILLATOR OUTPUT-SQUARE HCMOS

Line	Parameter	Test Condition	Value	Unit
7.1	Output waveform	Square HCMOS		
7.2	Output voltage level low		0.1 max	Vs
7.3	Output voltage level high		0.9 min	Vs
7.4	Rise and fall times	Measured with $V_s = 3.3V$	8 max	ns
7.5	Rise and fall times	Measured with $V_s = 5.0V$	7 max	ns
7.6	Duty cycle	Measured at 50% level	45 to 55	%
7.7	Load		15 max	pF

8.0 OSCILLATOR OUTPUT-SQUARE ACMOS

Line	Parameter	Test Condition	Value	Unit
8.1	Output waveform	Square ACMOS		
8.2	Output voltage level low		0.1 max	Vs
8.3	Output voltage level high		0.9 min	Vs
8.4	Rise and fall times	Measured with Vs = 3.3V	3 max	ns
8.5	Rise and fall times	Measured with Vs = 5.0V	2 max	ns
8.6	Duty cycle	Measured at 50% level	40 to 60	%
8.7	Load		50 max	pF

9.0 TRISTATE CONTROL

Line	Parameter	Test Condition	Value	Unit
9.1	Output enabled	Pad 2 open circuit or high	0.6 min	Vs
9.2	Output disabled	Pad 2 low	0.2 max	Vs

10.0 PHASE NOISE

Line	Parameter	Test Condition	Value	Unit
10.1	SSB phase noise power density at 1Hz offset	Typical values for a 13MHz oscillator at 25°C	-65	dBc/Hz
10.2	SSB phase noise power density at 10Hz offset	Typical values for a 13MHz oscillator at 25°C	-95	dBc/Hz
10.3	SSB phase noise power density at 100Hz offset	Typical values for a 13MHz oscillator at 25°C	-120	dBc/Hz
10.4	SSB phase noise power density at 1kHz offset	Typical values for a 13MHz oscillator at 25°C	-135	dBc/Hz
10.5	SSB phase noise power density at 10kHz offset	Typical values for a 13MHz oscillator at 25°C	-140	dBc/Hz
10.6	SSB phase noise power density at 100kHz offset	Typical values for a 13MHz oscillator at 25°C	-145	dBc/Hz

11.0 OTHER FEATURES

Line	Parameter	Description
11.1	Reference voltage, Vref	Available on request. Please contact Rakon

12.0 ENVIRONMENTAL

Line	Parameter	Description
12.1	Shock	IEC 60068-2-27 test Ea. 980 m/s ² duration, half sine pulse, 3 shocks in each direction along three mutually perpendicular axes
12.2	Vibration	IEC 60068-2-6 test Fc. 10-60Hz 1.5mm displacement, 60-2000Hz at 98.1 m/s ² , 30 minutes in each of three mutually perpendicular axes at 1 octave per minute
12.3	Storage temperature	-55°C to 125°C

13.0 PIN CONNECTIONS

Line	Parameter	Description
13.1	Pin 1	Voltage Control (optional, if not used do not connect)
13.2	Pin 2	Tri-state control
13.3	Pin 3	GND
13.4	Pin 4	Output
13.5	Pin 5	Vref (optional, if not used do not connect)
13.6	Pin 6	+Vs

14.0 MARKING

Line	Parameter	Description
14.1	Type	Laser marked
14.2	Line 1	[RAKON Exxxx] RAKON, Part Number (Exxxx)
14.3	Line 2	[xx.x MHz] Frequency (MHz)
14.4	Line 3	[Δ YYWWL] Pad 1 / Static sensitivity identifier (Δ), Device date / location code (YYWWL)

15.0 MANUFACTURING INFORMATION

Line	Parameter	Description
15.1	Reflow shift	Solder reflow processes as per reflow profile diagram. Solderability: MIL-STD-202, method 208, category 3
15.2	Packaging description	Quantities \geq 100 pieces will be supplied on tape & reel

16.0 NOTES

Line	Parameter	Description
16.1	Note 1	Frequency range available dependent on output type. HCMOS: 1-50MHz, sinewave: 8-50MHz, AC MOS: 1-80MHz, clipped sinewave: 8-50MHz
16.2	Note 2	Higher pulling may be available as a custom option depending on nominal frequency and stability - please contact the sales office: sales@rakon.com

Drawing Name: CFPT9050 Model Drawing



TOP VIEW

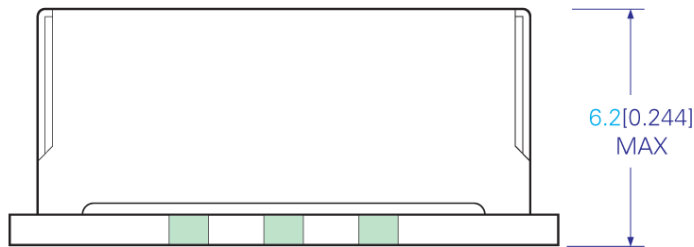

SIDE VIEW

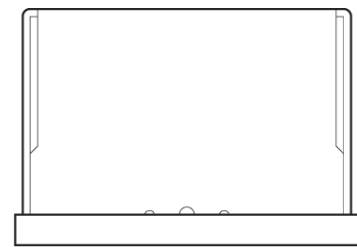

END VIEW

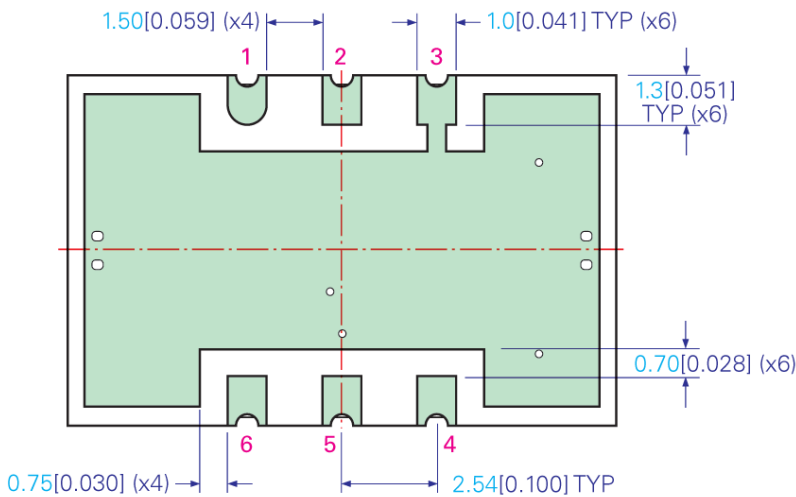

BOTTOM VIEW

NOTE: Pin connections are detailed in the specification

TITLE: CFPT9050 MODEL OUTLINE DRAWING

FILENAME: CFPT9050_MD

RELATED DRAWINGS:

REVISION: A

DATE: 26-Jul-10

SCALE: 5 : 1

Millimeters [inch]

Tolerance:

XX = ±0.5

X.X = ±0.2

X.XX = ±0.10

X.XXX = ±0.05

X° = ±1.0°

Hole = ±0.10

rakon

©2009 Rakon Limited

Drawing Name: CFPT9050 Model Code Builder

MODEL CODE BUILDER

CFPT 90XX XX X X XX

PRODUCT CODE
CFPT - Pluto®, USTCXO

PACKAGE CODE
905 / 906 - 14.7 x 9.2 mm

OUTPUT WAVEFORM & SUPPLY VOLTAGE CODE		
	3.3V	5V
HCMOS	58	51
Sine	59	53
ACMOS	60	55
Clipped Sine	61	57

TEMPERATURE STABILITY CODE						
Frequency Stability vs Operating Temperature Range						
±0.3ppm	±0.5ppm	±1.0ppm	±1.5ppm	±2.0ppm	±2.5ppm	
AP	EP	FP	CP	GP	HP	0 to 50°C
AC*	EC	FC	CC	GC	HC	0 to 70°C
AS*	ES	FS	CS	GS	HS	-20 to 70°C
AU*	EU*	FU	CU	GU	HU	-30 to 75°C
AX*	EX*	FX	CX	GX	HX	-40 to 85°C
		FY *	CY	GY	HY	-55 to 105°C

* Code may not be available for all frequency

RoHS CODE
LF - RoHS compliant

FREQUENCY ADJUSTMENT CODE

A - Frequency adjustment (standard option):
 ≥ ±5ppm min, frequency < 20MHz
 ≥ ±7ppm min, frequency ≥ 20MHz

B - No frequency adjustment initial calibration
 @ 25°C ≤ ±0.5ppm

C - High pulling ±10ppm to ±50ppm can be available depending on frequency and stability options. Please consult our sales officer

REFERENCE VOLTAGE CODE

1 - No output (standard option)
2 - 2.2V, for Min. Vs > 2.4V
3 - 2.7V, for Min. Vs > 3.0V
4 - 4.2V, for Min. Vs > 4.0V

Note: Maximum load current (mA) = Vref/10

EXAMPLE:

CFPT 9060 FY 1 A LF

CFPT - Pluto®, USTCXO

9060 - 14.7 x 9.2 mm, ACMOS, 3.3V

FY - ±1.0ppm, temperature range -55°C to 105°C

LF - RoHS compliant

A - Pin 1 Frequency adjustment (standard option):
 ≥ ±5ppm min, frequency < 20MHz
 ≥ ±7ppm min, frequency ≥ 20MHz

1 - No output (standard option)

TITLE: CFPT9050 MODEL CODE BUILDER

FILENAME: CFPT9050_MC

RELATED DRAWINGS:

REVISION: A

DATE: 14-Mar-11

SCALE: NTS

Millimeters [inch]

Tolerance:
 XX = ±0.5
 X.X = ±0.2
 X.XX = ±0.10
 X.XXX = ±0.05
 X^o = ±1.0°
 Hole = ±0.10

rakon

©2009 Rakon Limited

Drawing Name: CFPT9000 Series Test Circuit

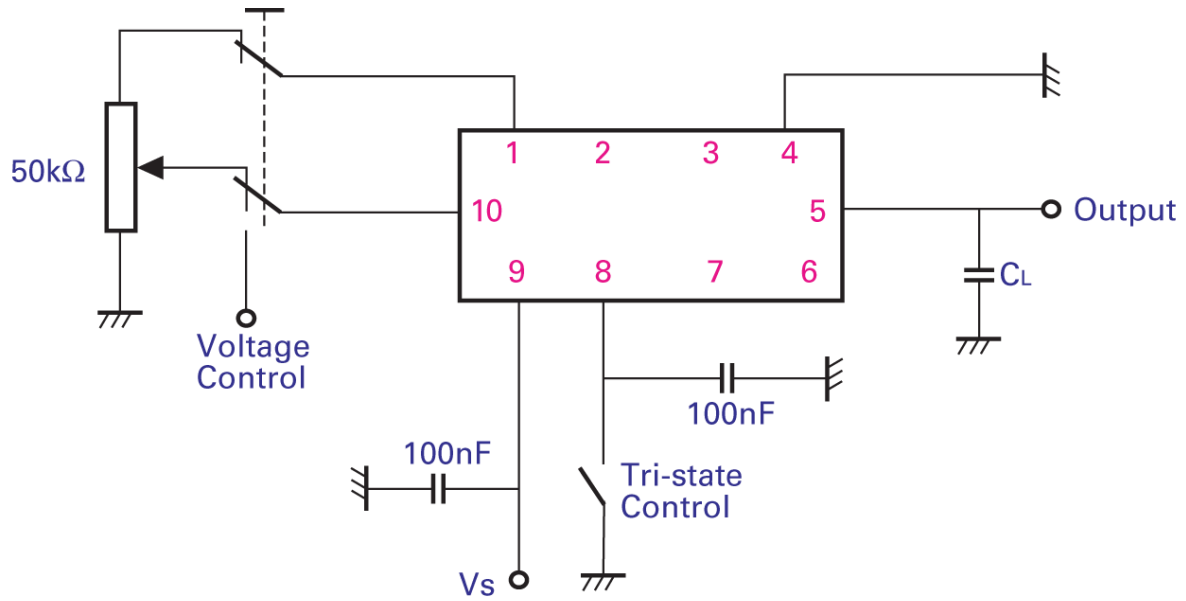

TITLE: CFPT9000 SERIES TEST CIRCUIT

RELATED DRAWINGS:

FILENAME: CFPT9000_TC

REVISION: A

DATE: 12-Mar-10

SCALE: NTS

Millimetres [inch]

rakon

©2009 Rakon Limited

Drawing Name: CFPT9050 Output Waveform Chart

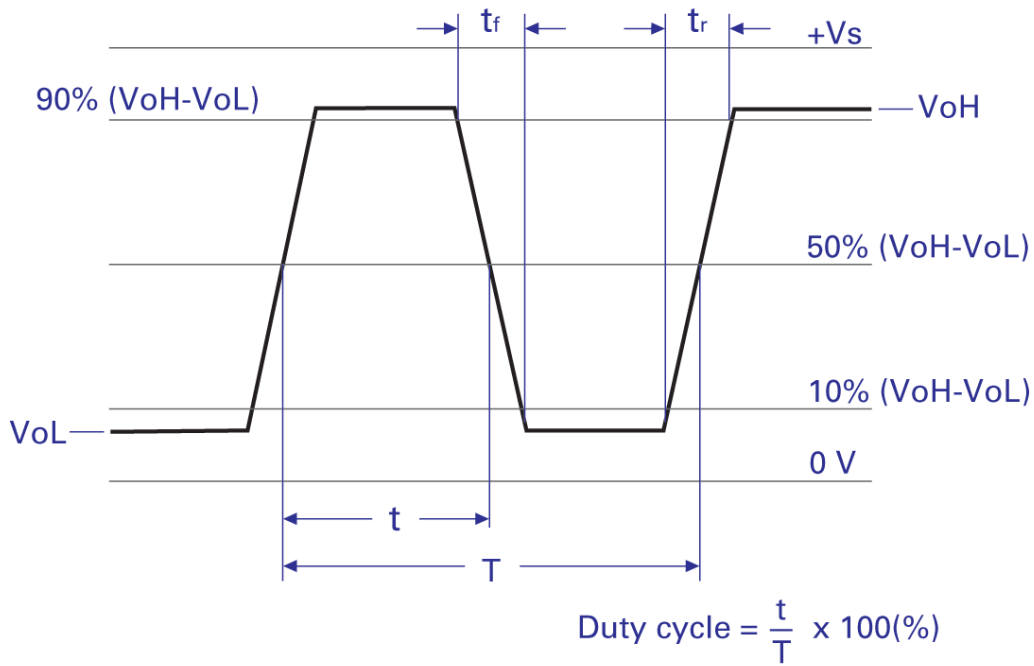

TITLE: CFPT9050 SERIES OUTPUT WAVEFORM - HCMOS

FILENAME: CFPT9050_OW

RELATED DRAWINGS:

REVISION: A

DATE: 19-Jul-10

SCALE: 5 : 1

Millimeters [inch]

Tolerance:

XX = ±0.5

X.X = ±0.2

X.XX = ±0.10

X.XXX = ±0.05

X° = ±1.0°

Hole = ±0.10

rakon

©2009 Rakon Limited

Drawing Name: CFPT9050 Series Reflow Profile

Pb-Free Reflow Soldering Profile *

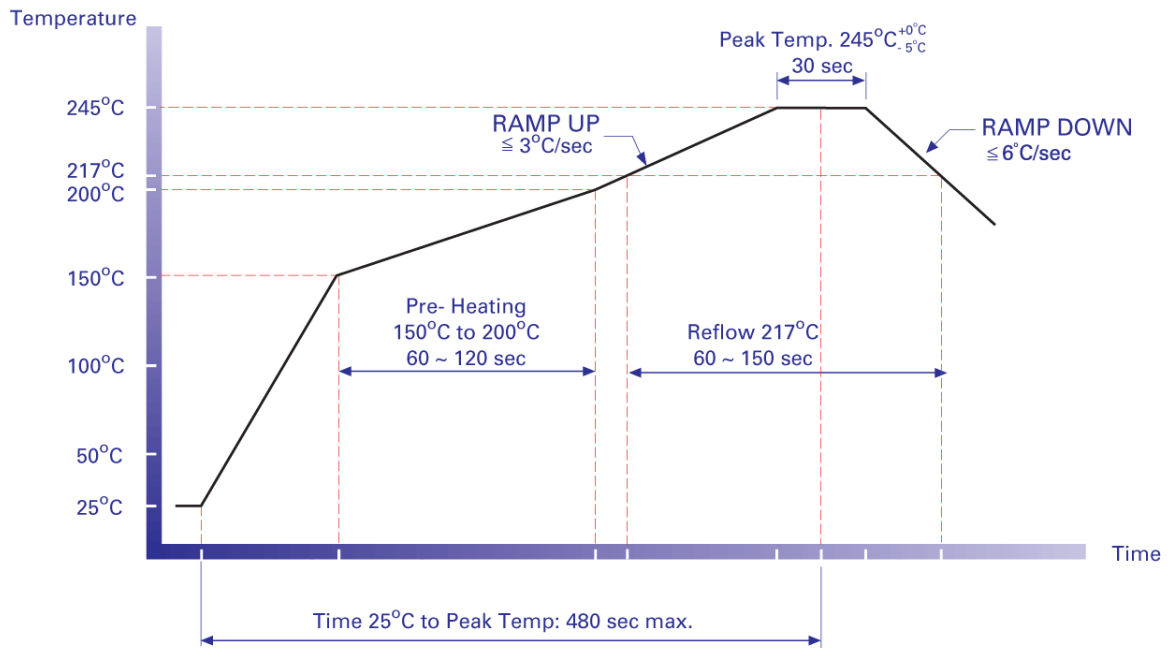

Sn-Pb Eutectic Reflow Soldering Profile *

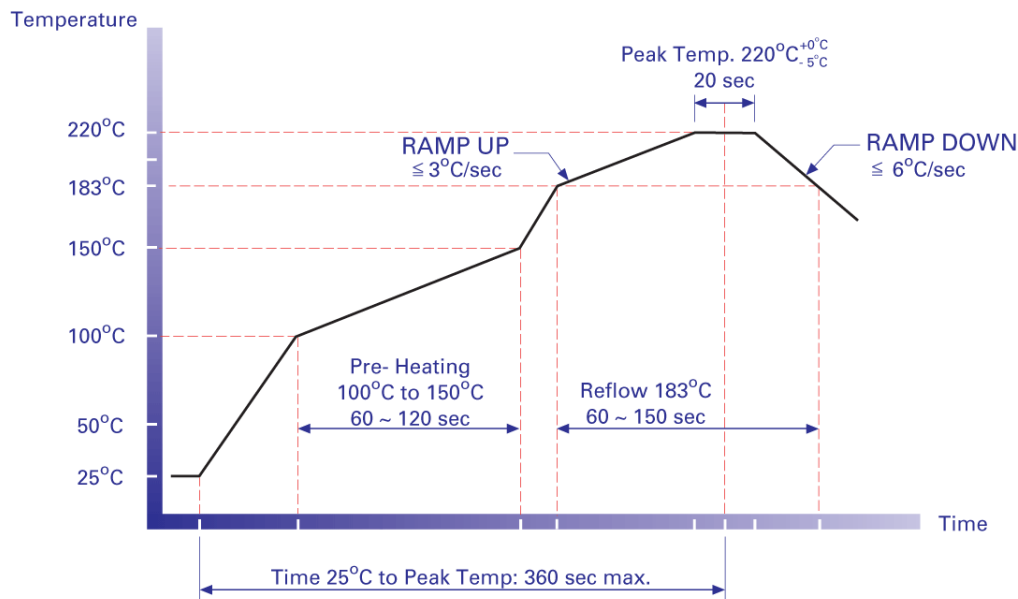

*** NOTE:**

These profiles were used during the qualification testing of the product and therefore represent worst case conditions. They are not recommended for use by the customer in the actual assembly of these parts.

TITLE: CFPT9050 SERIES REFLOW PROFILE

FILENAME: CFPT9050_RF

RELATED DRAWINGS:

REVISION: B

DATE: 13-Sep-10

SCALE: NTS

Millimeters [inch]

Tolerance:

XX = ± 0.5

X.X = ± 0.2

X.XX = ± 0.10

X.XXX = ± 0.05

X^o = $\pm 1.0^{\circ}$

Hole = ± 0.10

rakon

©2009 Rakon Limited

冠杰电子

0755-27839151

guanjiiedz@163.com



www.guangjiiedz.com