

SMD TYPE CERAMIC (SMD 6 x 3.5)

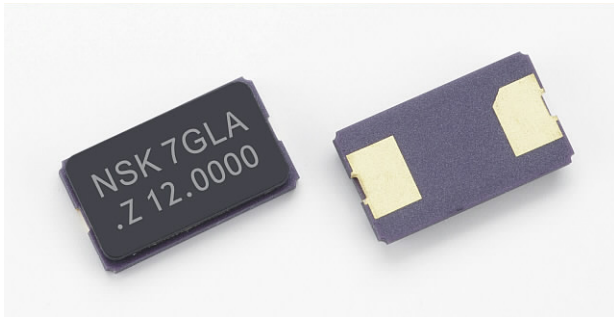

Application of SMD crystal:

- Blue tooth
- PDA
- Notebook
- Digital camera
- MP3
- Wireless Lan

{Features}

1.1mm thickness is equal to SMD-type IC
 Excellent reliability and environment capability
 High-density mounting-type SMD
 Excellent vibration resistance & shock resistance



Electrical Specification:

Model	NXC-63-APA-GLASS
1.Frequency	
Frequency Range	13.0 ~ 125.000 MHz
Frequency Tolerance at 25 °C ± °C	±0 ~ ±100 ppm (TYP.)
Frequency Stability Over Operating Temp Range	±0 ~ ±100 ppm (TYP.)
2.Environmental Condition	
Operating Temp Range	-10 °C~ +60 °C,-20 °C~ +70 °C or customer requirement
Storage Temp Range	-40 °C ~ +85 °C
Aging Rate	±1ppm , ±2ppm , ±3ppm/year
3.Electrical Specifications	
Test Circuit	S&A 250B
Load Capacitance	6 pF ~ 32 pF, series or special
Drive Level	1uW ~ 100uW or special
Shunt Capacitance	7.0pF max

Equivalent Series Resistance(ESR) VS Frequency:

Frequency (MHz)	Oscillation Mode	NXC-63-APA-GLASS
13.0 ~ 25.0	Fundamental	60
25.1 ~ 52.0	Fundamental	50
45.1 ~ 80.0	3rd overtone	80
80.1 ~ 125.0	3rd overtone	60



Dimensions: (mm)

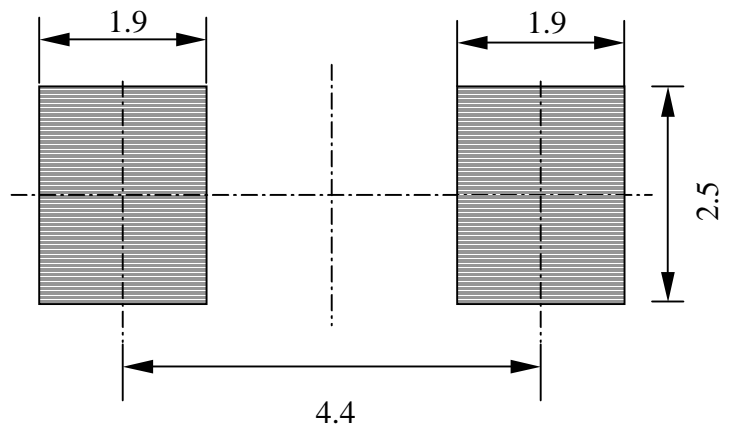
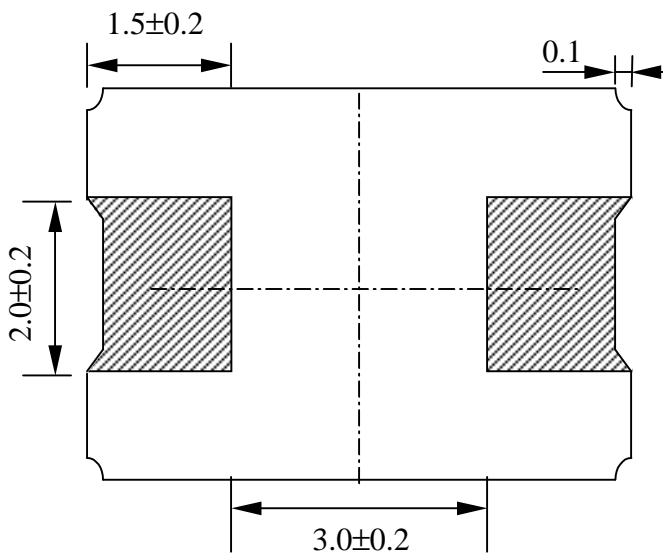
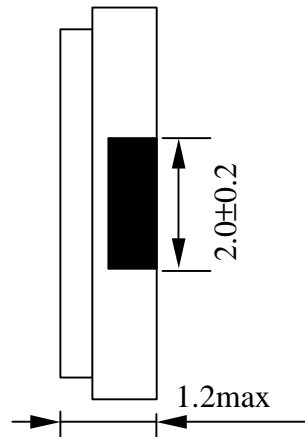
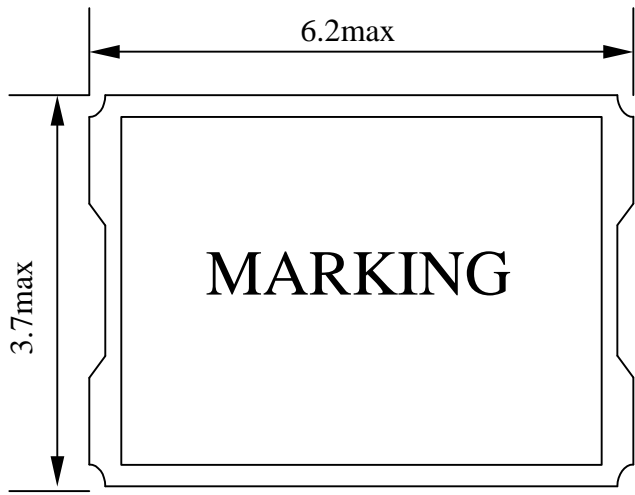

(Recommended Land Pattern)

Tape specification (mm):

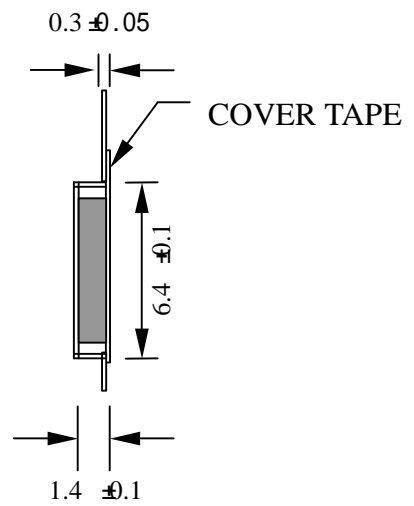
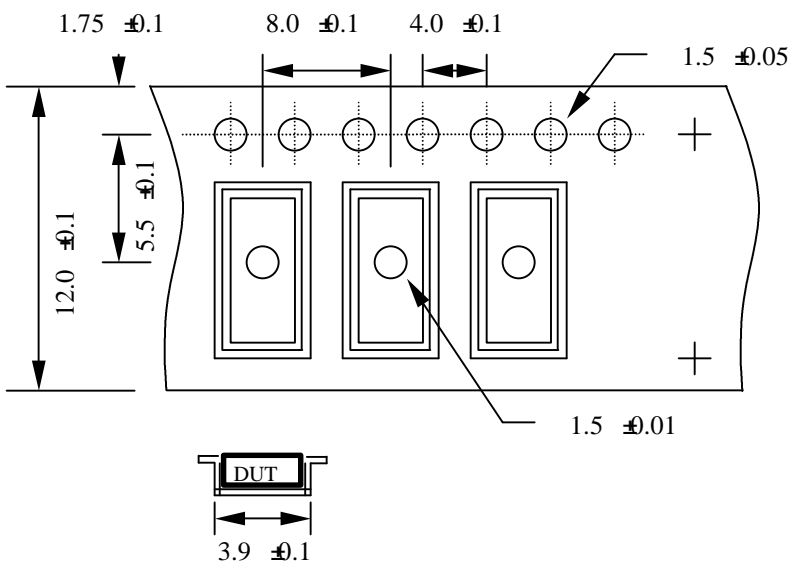

Reel packing (mm):

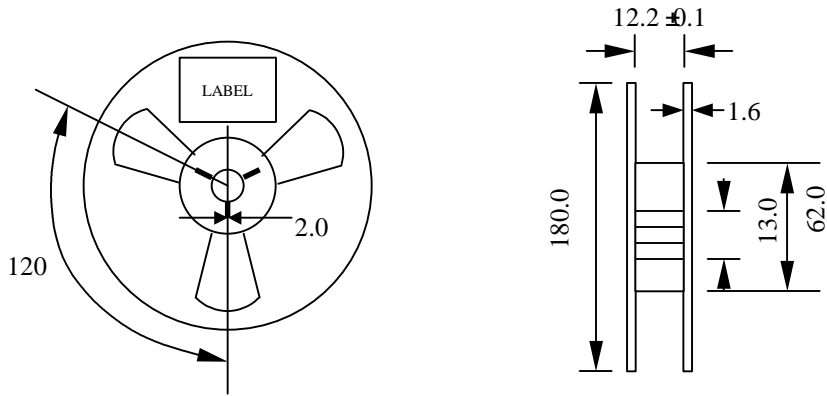

Reflow Temperature profile:

